

INSTRUCTION MANUAL

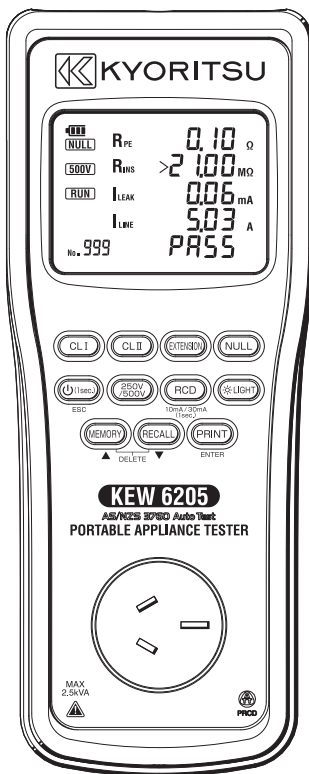

PORTABLE APPLIANCE TESTER

KEW6205



**KYORITSU ELECTRICAL
INSTRUMENTS WORKS, LTD.**

CONTENTS

1. Safe testing	3
2. Product summary and explanation.....	6
2.1 Product summary	6
2.2 Test Function.....	6
2.3 Features	6
2.4 Tester layout.....	7
2.4.1 Function Switches.....	7
2.4.2 LCD indications.....	9
2.4.3 Connector	11
2.5 Accessories	12
2.6 Optional accessories	13
3. Specification	14
3.1 General specification, measuring range and accuracy	14
3.2 General specification.....	16
3.3 Threshold and display.....	17
4. Preparation before a measurement.....	18
4.1 Visual inspection	18
4.2 Battery Voltage Check.....	18
4.3 Setting	18
4.3.1 Null setting	18
4.3.2 Voltage setting for insulation resistance measurement (How to change between 250V and 500V).....	19
5. Measuring method	20
5.1 Class I Test.....	20
5.2 Class II Test.....	23
5.3 Extension Leads Test	28
5.4 RCD TEST	32
6. Memory/ Recall function	37
6.1 Memory function	37
6.2 Recall function	38
6.3 Delete the saved data	39
7. Print function	40
8. USB communication	43
9. Clock mode	44
10. Backlight.....	45
11. Battery / Fuse replacement.....	45
11.1 Battery Replacement.....	45
11.2 Fuse Replacement	46
12. Shoulder strap attachment.....	46
13. Maintenance.....	47

1. Safe testing

Electricity is dangerous and can cause injury and death. Always treat it with the greatest of respect and care. If you are not quite sure how to proceed, then stop, take advice from a qualified person.

This instruction manual contains warning and safety rules which must be observed by the user to ensure safe operation of the Tester and retain it in safe condition. Therefore, read through these operating instructions before using the Tester.

IMPORTANT:

The Tester must only be used by a competent and trained person and operated in strict accordance with these instructions.

KYORITSU will not accept liability for any damage or injury caused by misuse or non-compliance with the instructions or with the safety procedures.

It is essential to read and to understand the safety rules contained in these instructions and with the safety procedures.

The symbol  indicated on the Tester means that the user must refer to the related sections in the manual for safe operation of the Tester.

Be sure to carefully read instructions following each symbol  in this manual.

 **DANGER** : is reserved for conditions and actions that are likely to cause serious or fatal injury.

 **WARNING**: is reserved for conditions and actions that can cause serious or fatal injury.

 **CAUTION** : is reserved for conditions and actions that can cause injury or instrument damage.

DANGER

- The Tester can be connected only to the commercial power of 100V – 253V, 50Hz.
- For safety reasons, only use the Test Leads designed to be used with this Tester and recommended by KYORITSU.
- Use only grounded mains outlets to supply the Tester.
- Do not touch the device under test while testing is in progress.

⚠ DANGER

- Since a high voltage 250V or 500V is being output continuously, when measuring insulation resistance, the user may get an electrical shock. Any capacitors in the appliance under test may become charged during testing and may contain hazardous voltages do not touch them.
- When testing, always be sure to keep your fingers behind the safety protective finger guard on the test leads.
- Disconnect the Tester from the power supply when measurement is finished.
- Do not leave the Tester with connected to the power supply.

⚠ WARNING

- Never open the instrument case – because dangerous voltages are present. Only fully trained and competent electrical engineers should open the case.
- If abnormal conditions of any sort are noted (such as a faulty display, unexpected readings, broken case, cracked test leads, etc.) do not use the Tester and return it to your distributor for inspection and repair.
- Never attempt to use the Tester if the Tester or your hands are wet.
- Stop using the test lead if the outer jacket is damaged and the inner white jacket is exposed.

⚠ CAUTION

- When using Test Leads with the alligator clip, be sure to check the alligator clip is firmly connected to the metal part of the device under test. Otherwise, inaccurate measurements or arcing at the contacts may occur.
- The rated measuring voltage for the insulation test is 250V or 500V DC. If this voltage seems too high for the appliance under test contact the appliance manufacturer for advice.
- When testing a faulty appliance, it may trip the circuit breaker of main power supply during test and may cause interruption of service. Be careful when the same main power supply is used for PCs.
- We are not liable for loss of data on PC during testing with the Tester. The appliance under test is powered on during most tests, but please turn it to the OFF position after testing.
- Use a very slightly damp cloth for cleaning the Tester. Do not use abrasives or solvents.

Measurement Category

To ensure safe operation of measuring instruments, IEC 61010 establishes safety standards for various electrical environments, categorized as O to CAT IV, and called measurement categories. Higher-numbered categories correspond to electrical environments with greater momentary energy, so a measuring instrument designed for CAT III environments can endure greater momentary energy than one designed for CAT II.

- O : Circuits which are not directly connected to the mains power supply.
- CAT II : Electrical circuits of equipment connected to an AC electrical outlet by a power cord.
- CAT III : Primary electrical circuits of the equipment connected directly to the distribution panel, and feeders from the distribution panel to outlets.
- CAT IV : The circuit from the service drop to the service entrance, and to the power meter and primary over-current protection device (distribution panel).

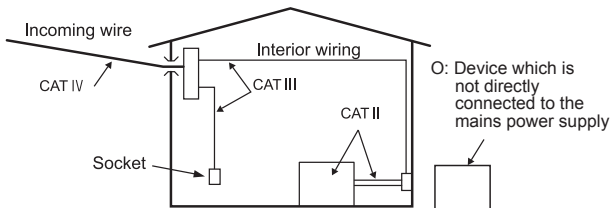

2. Product summary and explanation

2.1 Product summary

KEW6205 (Tester) is a hand-held portable appliance tester and can test electrical safety of Class I and Class II appliances. The Tester performs test and indicates PASS/ FAIL result complying with the criteria of judgement defined in AS/NZS3760.

As a guide, AS/NZS3760 defines these two categories as follows:

Class I : Appliances which have a functional insulation throughout and an earth connected case. These are often described as earthed appliances.

Class II : Appliances which have both functional and additional insulation where any metal parts cannot become “Live” under fault conditions.

2.2 Test Function

- CL I:
 - Protective conductor resistance test (Test current 200mA DC nominal)
 - Insulation test (250V or 500V)
 - Run leakage current test
 - Load current test
- CL II:
 - Insulation test (250V or 500V)
 - Run leakage current test
 - Load current test
- Extension Lead test
 - Protective conductor resistance test (Test current 200mA DC nominal)
 - Insulation test (250V or 500V)
 - L-N Short test
 - Polarity test
 - Run leakage current test
- RCD test





2.3 Features

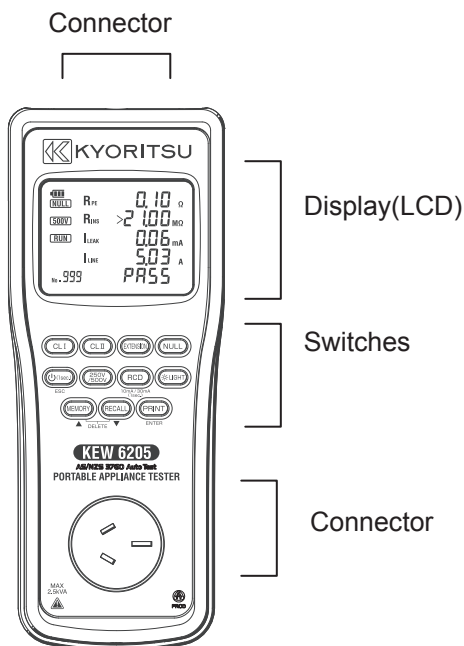





- Check for whether the appliance is switched ON.
- Selection for 250V or 500V on the insulation resistance test.
- Null function for the protective conductor resistance test.
- Auto-testing & PASS/ FAIL indication with backlight
- Auto-power-off

2.4 Tester layout



2.4.1 Function Switches

Switch		Details
	CLI switch	Short press: Starts CLI test. (Continuity test: 1 sec.) Long press: Starts CLI test. (Continuity test: 5 sec.)
	CLII switch	Starts CLII test.
	Extension switch	Short press: Starts Extension lead test. (Continuity test: 1 sec.) Long press: Starts Extension lead test. (Continuity test: 5 sec.)
	NULL switch	Performs NULL.

Switch		Details
	Power switch	Short press: Works as ESC switch. Returns to the stand-by screen when a test is halted by "FAIL" result. Long press: Turns on/ off the Tester.
	250V /500V	Switches output voltage for insulation resistance test between 250 V and 500 V. (Default setting: 250 V)
	Light switch	Short press: Turns on/ off LCD backlight. Long press: Enters into clock mode.
	RCD switch	Switches to RCD stand-by screen. Another press on the stand-by screen starts RCD test. Long press on the screen switches test current between 10 mA and 30 mA. (Default setting: 30 mA)
	Memory switch	Saves test results.
	Recall switch	Recalls the saved data.
	Print switch	Transfers the displayed test result to a printer.

2.4.2 LCD indications

<All symbols to be displayed on the LCD>

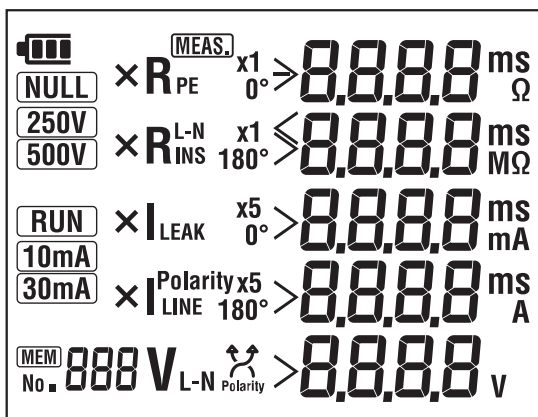

Display symbols

NULL	NULL value has been set.
250V 500V	Rated voltage for insulation resistance test
RUN	Leakage current test under actual working condition
10mA 30mA	Rated current for RCD test
MEAS.	Measurement in progress
R_{PE}	Protective conductor resistance
R_{INS}	Insulation resistance
R_{INS}^{L-N}	Insulation resistance between L-N (Extension Lead Test)
I_{LEAK}	Leakage current
I_{LINE}	Load current

V_{L-N}	Mains voltage
Polarity	Polarity test result
X	Indicates items failed the test.
x1 x1 x5 x5 0° 180° 0° 180°	RCD test range
OFF?	Prompts to check and turn on a DUT.
 Polarity	Indicates the connection for RCD test is incorrect.
Good	Indicates the resistance between L-L (N-N) is less than 10 Ω and polarity is correct.
OPEN	Open circuit warning –resistance between L-L (N-N) is 10 Ω or higher at polarity test.
Cross	Crossed L-N polarity warning - resistance between L-N (N-L) is 10 Ω or lower at polarity test.
< 0.10 M Ω	Short-circuited L-N warning – resistance between L-N is 100 k Ω or lower at insulation test. (Extension Lead Test)
UFH	Fault voltage of 50 V or higher is detected at RCD test.
PASS	Test result is “PASS” .
FAIL	Test result is “FAIL” .
no	RCD tripped at fault current detection.
> 30v	Warning – voltage of 30 V or higher is being applied to the IEC connector while a function other than RCD is selected.
MEM	Blinks while saving data.
No. 888	Data no. given for the saved data.

2.4.3 Connector

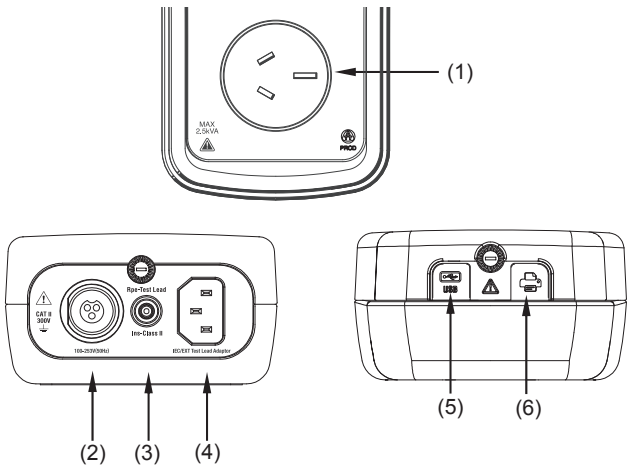

(1)	Test socket	Insert the mains plug of DUT to this socket for the polarity test of protective conductor resistance, insulation resistance and leakage current test.
(2)	Terminal for mains lead	This terminal is connected to a mains supply via MODEL7277.
(3)	Rpe Test Lead terminal	Connect the test lead MODEL7129A to this terminal for the measurement of protective conductor resistance, and clip the metal parts of DUT with the alligator clip.
(4)	Terminal for Extension leads adaptor	It corresponds to L, N, E of test socket, and the extension leads adaptor connected with the cord reel to be plugged to it.
(5)	Terminal for USB cable	Connect the optional USB cable to this terminal to transfer the internal data to a PC.
(6)	Terminal for printer cable	This terminal is connected to a printer with the optional printer cable MODEL7275.

2.5 Accessories

(1) Mains lead MODEL7277

This mains lead can be connected to the mains supply so that the Tester supply power to the DUT.

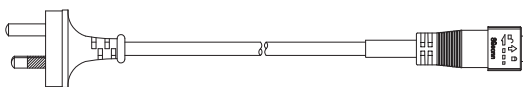

(2) Test Lead with safety alligator clip (MODEL7129A) and Probe with Blade type Prod(MODEL7161A). The probe and alligator clip are interchangeable.

Please use it according to a measurement use.

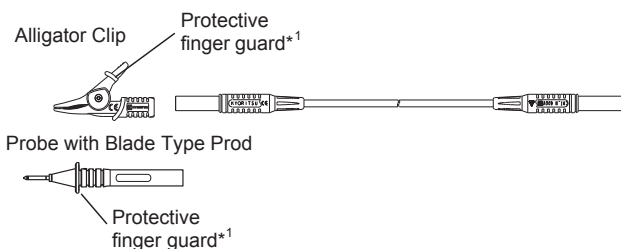

*1 Protective finger guard is a part providing protection against electrical shock and ensuring the minimum required air and creepage distances.

(3) Extension leads adaptor MODEL7276

This is for connecting the Tester and an extension lead (cord reel).

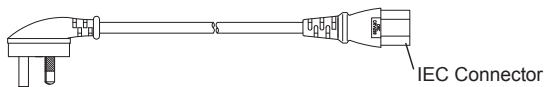

(4) Soft case MODEL9193

(5) Six size AA alkaline batteries(LR6)

(6) Instruction manual

(7) Shoulder strap with Buckle

2.6 Optional accessories

(1) Printer cable MODEL7275

(2) USB cable with "KEW Report(Software)" MODEL8263-USB

3. Specification

3.1 General specification, measuring range and accuracy

Mains voltage indication:

Display range	30 - 270 V
Hi/ Lo indication	< 30 V: No voltage indication > 270 V: >270 V
Resolution	1 V
Accuracy	±5 V

* Voltage between L-N of mains lead terminal is measured and displayed at voltage test.

Protective conductor resistance test

Measuring range	0.00 - 20.00 Ω (NULL value included.) *
Over-range indication	> 21.00 Ω
Resolution	0.01Ω
Open-circuit voltage	5 V ±0.4 V DC
Measuring current	200 mA DC (nominal value)
Accuracy	±3%rdg ±5dgt

* Resistances exceeding 3 Ω cannot be canceled by NULL function.

Insulation resistance test

Rated voltage	250V	500V
Measuring range	0.00 - 20.00 MΩ	
Over-range indication	> 21.00 MΩ	
Resolution	0.01 MΩ	
Rated voltage	250V DC +20%, -10% @ 1MΩ	500V DC+20%, -10% @ 1MΩ
Short-circuit current	1.5 mA DC or less	
Rated current	1 -1.2 mA @ 0.25 MΩ	1 -1.2 mA @0.5 MΩ
Accuracy	±2%rdg±3dgt	

Leakage current test under actual working condition:

(Load current is also measured.)

Item	Load current	Leakage current
Mains voltage range	100 - 253 V/ 50 Hz	
Measuring range	0.10 - 10.00 A rms	0.10 - 20.00 mA rms
Display range	0.00 - 12.00 A	0.00 - 21.00 mA
Over-range indication	> 12.00 A	> 21.00 mA
Resolution	0.01A	0.01mA
Accuracy	±10%rdg ±5dgt	±3%rdg ±5dgt
Max. rating	2.5 kVA max./ 15 sec. continuous	---

Insulation test between L-N at Extension Lead Test

Open-circuit voltage	4.5 V ±0.5 V DC
Criteria of judgement	100 kΩ ±20 kΩ or less: LCD shows “<0.10 MΩ” and the measurement is halted.

RCD test:

Four tests with the pre-set rated current are performed in the following sequence: ×1(0°)→×1(180°)→×5(0°)→×5(180°).

Rated voltage	230 V -15% +10% (50Hz)	
Rated current	10 mA/ 30 mA	
Function	×1	×5
Test duration	0.0 ms - 500.0 ms	0.0 ms - 40.0 ms
Energization	FS ±3%	
Test current accuracy	±3%	
Operating time accuracy	±2 ms (≤40 ms) ±8 ms (>40 ms)	

3.2 General specification





Reference conditions	Specifications are based on the following conditions, except where otherwise stated: - (1) Ambient temperature: $23\pm 5^{\circ}\text{C}$ (2) Relative humidity: 45 - 75% (3) Attitude: Horizontal (4) AC power supply: 230 V, 50Hz (5) Altitude: 2000m or less
Battery type	Six size AA alkaline batteries (LR6)
Operating temperature and humidity range	0°C to $+40^{\circ}\text{C}$, relative humidity: 85% or less (no condensation)
Storage temperature and humidity range	-20°C to $+60^{\circ}\text{C}$, relative humidity: 85% or less (no condensation)
Rate voltage and frequency	Rated voltage: 230 V -15% +10% Rated frequency: 50 Hz
Maximum load current at test socket	2.5 kVA (15sec.)
Outer dimension and weight	Outer dimension: 261(L) × 104 (W) × 57(D)mm Weight (including batteries): Approx. 940g
Auto power off	The Tester turns off automatically after 10 minutes.
Possible number of measurements where battery voltage is within the effective range (measuring every 30 sec.)	Approx. 3000 times (CLI Rpe: $0\ \Omega$, Rins: $1.1\ \text{M}\Omega$)

Applicable standards:

Instrument operation	AS/NZS3760:2010
Safety	IEC/EN61010-1 CAT II 300V-instrument IEC/EN61010-2-030 IEC/EN61010-031 MODEL7129A(CAT III 600V) *
EMC	EN61326-1, 2-2
Environmental standard	EN50581

*When the instrument and the test lead are combined and used together, whichever lower category either of them belongs to will be applied.

Symbols used on the Tester:

CAT II	Electrical circuits of equipment connected to an AC electrical outlet by a power cord.
	Double or reinforced insulation
	User must refer to the explanations in the instruction manual.
	Earth
 PRCD	ATT (Anti-Trip Technology) The Tester uses mains voltage across L-N for PRCD testing. It enables PRCD testing without tripping the RCD of mains power.
	Crossed-out wheel bin symbol (according to WEEE Directive: 2002/96/EC) indicating that this electrical product may not be treated as household waste, but that it must be collected and treated separately.

3.3 Threshold and display

Function	Protective conductor resistance	Insulation resistance	Leakage current
Class I	$RPE \leq 1\Omega$	$RINS \geq 1M\Omega$	$I_{LEAK} \leq 5mA$
Class II		$RINS \geq 1M\Omega$	$I_{LEAK} \leq 1mA$
Extension Lead	$RPE \leq 1\Omega$	$RINS \geq 1M\Omega$	$I_{LEAK} \leq 1mA$

RCD

RCD Type	Type I (10mA)		Type II (30mA)	
	x1	x5	x1	x5
	40ms		300ms	40ms

4. Preparation before a measurement

4.1 Visual inspection

Before starting a measurement, the user should undertake visual checks on the mains lead, case and that the correct type and rated fuse is fitted to the appliance under test. There should also be no evidence of damage of a nature that may impair the electrical safety of the appliance.

4.2 Battery Voltage Check

- (1) Insert batteries with reference to 11. *Battery/ Fuse replacement* in this manual.
- (2) Hold down Power switch 1 sec. to turn on the Tester.
- (3) Check the battery indicator displayed in the upper left corner of the LCD.

If just the last one segment of the indicator remains, the battery voltage is extremely low. Refer to 11. *Battery/ Fuse replacement* and replace batteries to perform further measurements.

If an empty battery indicator is displayed, the battery voltage is lower than the working voltage limit. Replace batteries immediately to keep accurate measurement.

Battery recommendation:

Use of alkaline battery is recommended. Use of other type of batteries may cause improper indication of battery level.

4.3 Setting

4.3.1 Null setting

AS/NZS3760 pass level for Protective conductor resistance is 1 Ω , which is a low value. So even the resistance of Test Leads will affect the measurement result.

The Tester can cancel the resistance of test lead by pressing **NULL**. The procedure of Null setting is shown below. The Null function is held in memory even when the Tester is turned off, so there's no need to Null the lead resistance every time. However, when replacing fuses or test leads, it is recommended to do a Null setting again.

Note:

Null setting is possible at both Class I Test and Extension Lead Test. However, only one Null value can be held in memory. For example, when the Null setting is carried out at Class I Test, the set value will also be used for Extension Lead Test (unless it is reset).

- (1) Insert Test Lead with probe (MODEL7161A) into the Rpe Test Lead terminal of the Tester, and contact the tip of the Test Lead with the earth contacts of the socket on the Tester.
- (2) Press NULL switch on any screen.

- (3) The screen switches to NULL screen, and NULL measurement starts. The LCD shows blinking “MEAS” mark and measured value during a measurement. The measured value is saved and subtracted from the further measured values.

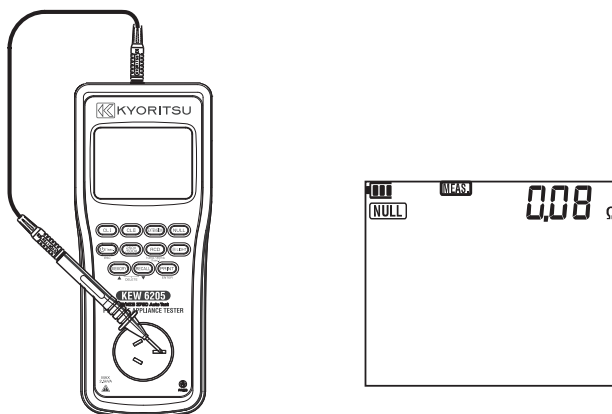

- (4) If the measured value is less than 3 Ω, previous NULL value is cleared and a new value is saved. When 3 Ω or higher is measured, previous NULL value is just cleared (NULL mark disappears).

4.3.2 Voltage setting for insulation resistance measurement (How to change between 250V and 500V)

Two different rated voltages, 250 V and 500 V, are available for insulation resistance test. Press 250V/500V switch on the stand-by screen or while measured result is being displayed at CL I/ CL II/ Extension lead test. Default setting is 250 V.

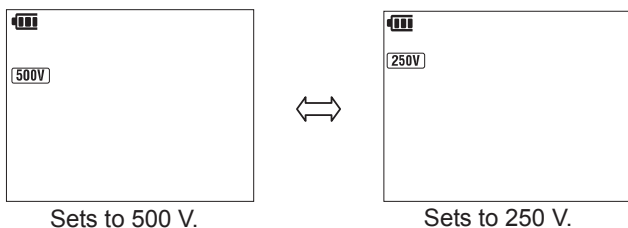

5. Measuring method

5.1 Class I Test

The purpose of the test carried out for Class I appliances is to check the resistance of earth continuity from exposed metal parts and the plug is below a certain level and the insulation resistance between live and neutral connected together and earth is $1M\Omega$ or more.

To perform Class I test, connect the mains plug of the appliance to the test socket (1) described in clause 2.4.3. Connector and the Rpe Test Lead terminal (3). To perform RUN leak test, connect Mains lead MODEL7277 to Mains lead terminal (2).

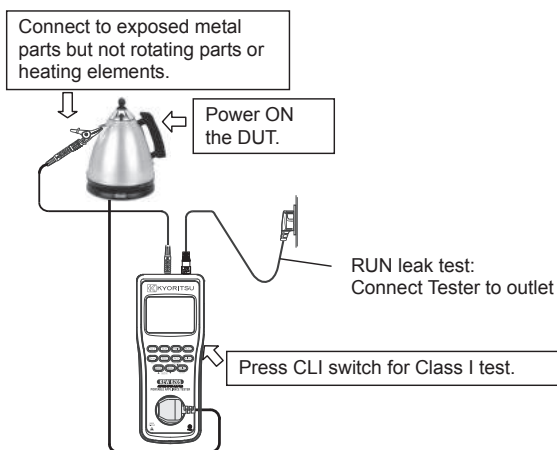

1. Continuity test	Earth continuity test between the exposed metal parts and plug
2. Insulation test	Between LINE, NEUTRAL and EARTH.
3. Leakage current test	RUN Leak test: Connect Tester to outlet: (Load current is also measured.)

CL I Test Flow

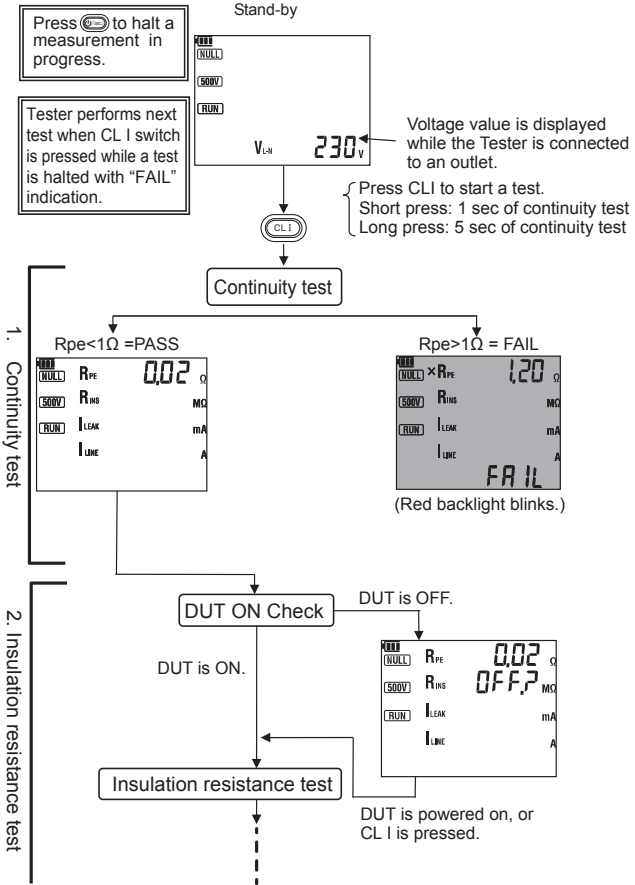

3. Leakage current test

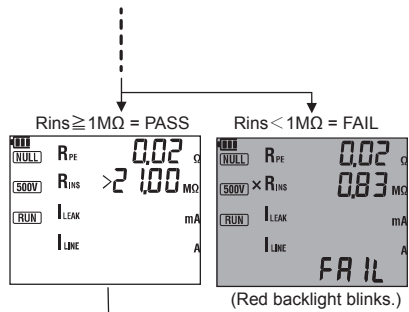

Check screen for RUN leakage test.
Buzzer sounds and blue backlight blinks.

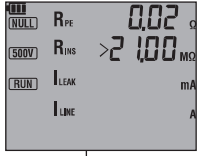

CL 1

RUN Leak/ Load current test

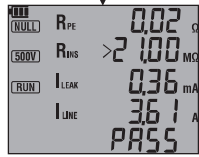

I_{LEAK} $\leq 5\text{mA}$ = PASS
(Green backlight blinks.)

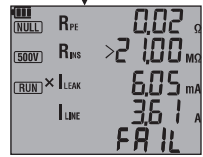

I_{LEAK} $> 5\text{mA}$ = FAIL
(Red backlight blinks.)

⚠ WARNING

- When conducting a leakage test the appliance will automatically power on and will operate in its normal manner. It is imperative that the appliance is secured safely before the test is carried out. Extra care needs to be taken with appliances which have heating elements and rotating parts.
- Firmly insert the plug of the appliance to the socket of the Tester. Plugs may get hot if Leakage current test is performed with improper connection.
- Do not connect/remove the plugs during Leakage current test. It may cause a reading error.
- Do not use the Tester on the device which has a power consumption of 2.5 kVA or more.

⚠ CAUTION

- Where DUT ON Check function detects that DUT is off, blinking “OFF?” appears in the LCD and the test is stopped. Turn on the DUT; then the Tester automatically resumes the test. Depending on DUTs, even they are turned on, blinking “OFF?” warning sometimes doesn't disappear and the Tester cannot continue the test automatically. In such a case, press CL I switch to continue the test.
- Follow the procedure described in 4.3.1 and undertake the NULL setting before a measurement.
- The alligator clip must make good contact with the enclosure of the appliance.
- Do not touch the appliance under test while testing is in progress. Since a high voltage of 250V/500V will be present and the user may get an electrical shock.
- When the terminal is open or the resistance value exceeds the measuring range, “ > ” (over range display) appears on the LCD.

5.2 Class II Test

The Class II appliances have the indication of “DOUBLE INSULATION” or the  symbol.

Class II test is performed to confirm insulation resistance and leakage current of the appliance are within the allowable range specified in the related standard.

To perform Class II test, connect the mains plug of the appliance to the test socket (1) described in clause 2.4.3. Connector and the Rpe Test Lead terminal (3). To perform RUN leak test, connect Mains lead MODEL7277 to Mains lead terminal (2).

Use the following setups, depending upon the type of appliance.

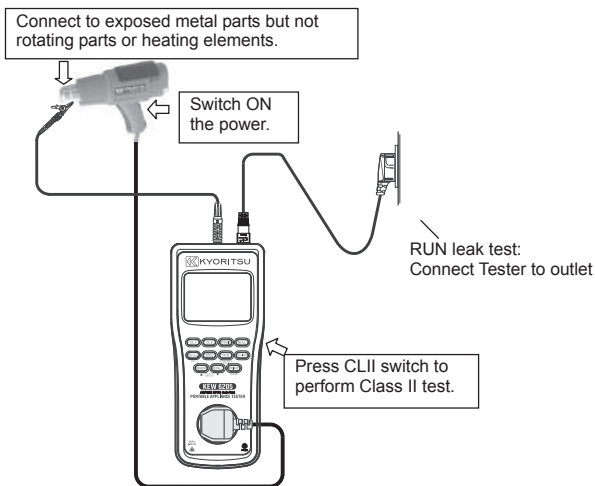

1. Insulation test	Between LINE, NEUTRAL and EARTH.
2. Leakage current test	RUN Leak test: Connect Tester to outlet. (Load current is also measured.)

CL II Test Flow

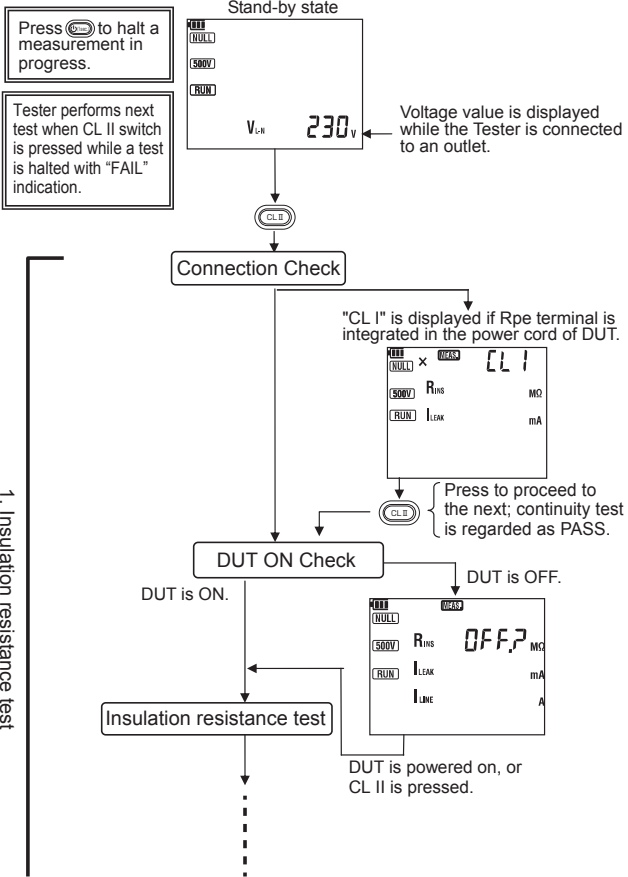

2. Leakage current test

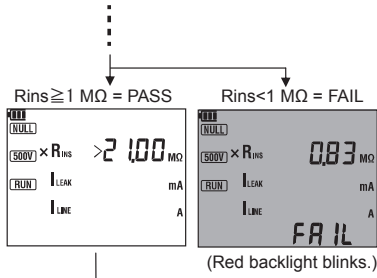

Check screen for RUN leakage test.
Buzzer sounds and blue backlight blinks.

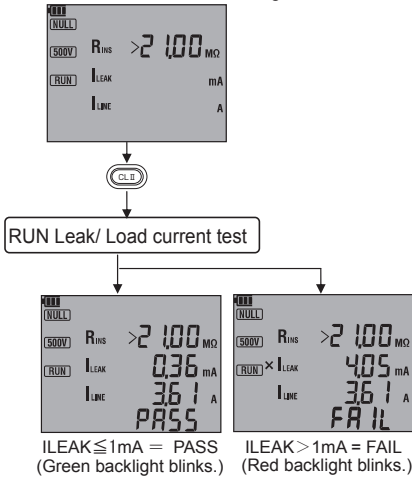

⚠ CAUTION

- Where DUT ON Check function detects the DUT is off, blinking " OFF?" appears in the LCD and the test is stopped. Turn on the DUT; then the Tester automatically resumes the test. Depending on DUTs, even they are turned on, blinking " OFF?" warning sometimes doesn't disappear and the Tester cannot continue the test automatically. In such a case, press CL II switch to continue the test.
- When the terminal is open or the resistance value exceeds the measuring range, ">" mark (over range display) appears on the LCD.
- Do not touch the appliance under test while testing is in progress. Since a high voltage of 250V or 500V will be present and the user may get an electrical shock.

⚠ WARNING

- When conducting a leakage test the appliance will automatically power on and will operate in its normal manner. It is imperative that the appliance is secured safely before the test is carried out. Extra care needs to be taken with appliances which have heating elements and rotating parts.
- Firmly insert the plug of the appliance to the socket of the Tester. Plugs may get hot if Leakage current test is performed with improper connection.
- Do not connect/remove the plugs during Leakage current test. It may cause a reading error.
- Do not use the Tester on the device which has a power consumption of 2.5 kVA or more.

5.3 Extension Leads Test

This test is for extension leads, and checks for;

- Protective conductor resistance between accessible conductive parts and connection of protective earth.
- Insulation resistance between L/N and PE.
- Insulation test between L-N
- Polarity check of the Line and Neutral terminal of plug and socket
- Run leakage current test (Run leakage current test on Extension Leads Test doesn't measure load current.)

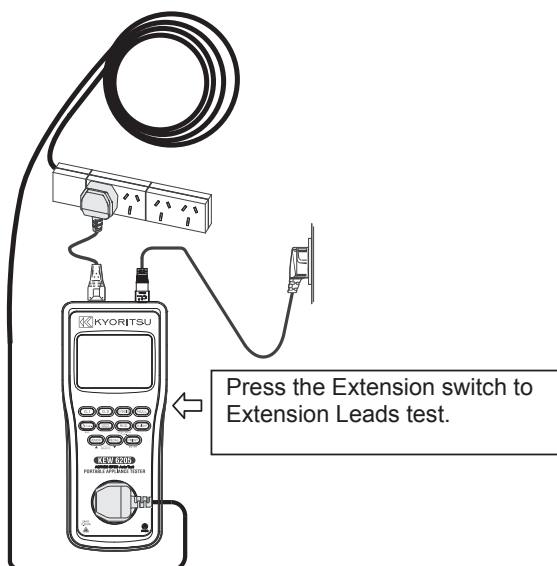

1. Continuity test	For PE terminal of Extension Leads
2. Insulation test	Between LINE, NEUTRAL and EARTH, and between LINE and NEUTRAL
3. Polarity check	For LINE and NEUTRAL
4. Leakage current test	RUN Leak test: Connect Tester to outlet:

Extension Lead test flow

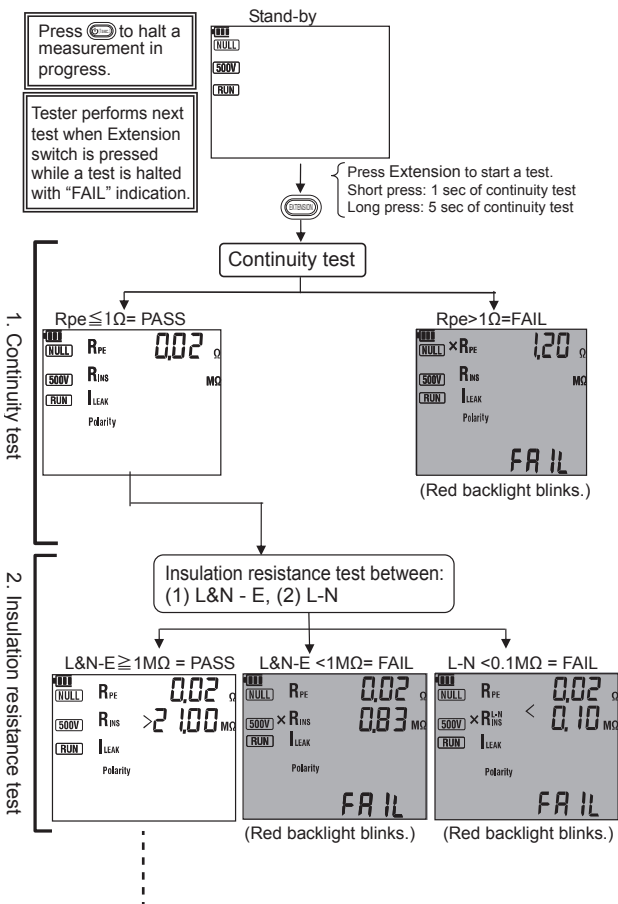

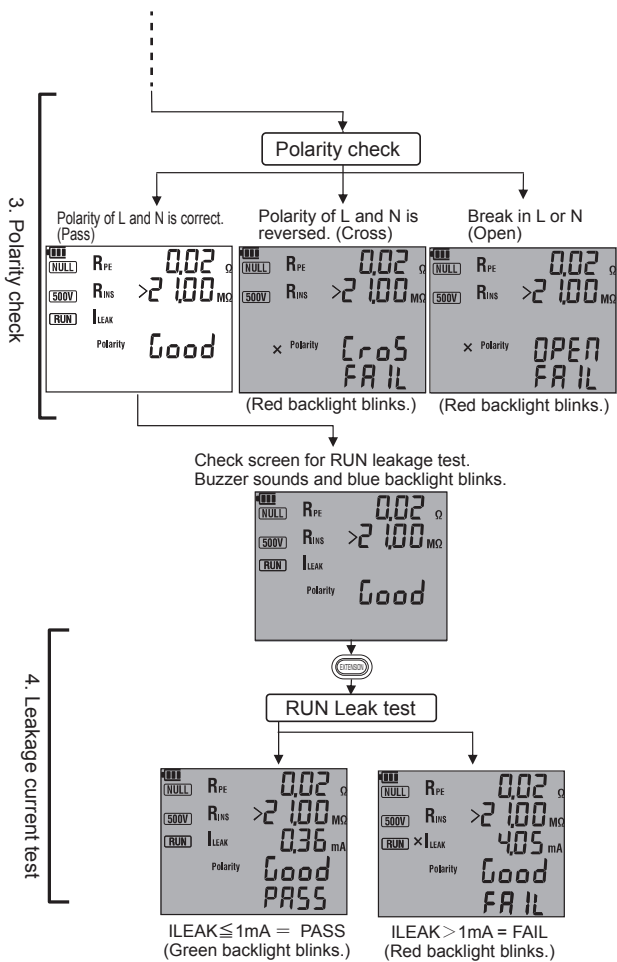

⚠ CAUTION

- Follow the procedure described in 4.3.1 and do Null setting before a measurement, but use the short MODEL7276 lead instead of the MODEL 7129A test lead, by plugging the MODEL 7276 into the Extension Lead Adaptor terminal and the AU socket on the front of the unit.
- When the terminal is open or the resistance value exceeds the measuring range, “ > ” (over range display) appears on the LCD.
- Do not touch the device under test while testing is in progress. Since a high voltage of 250V or 500V will be present, the user may get an electrical shock.

5.4 RCD TEST

(1) PRCD test

This test is to test and confirm a PRCD (Portable Residual Current Device) trips within the rated time by applying specified current. The Tester incorporates a circuit to test PRCD with Rated Tripping Current ($I\Delta n$) of 10 mA or 30 mA. PRCD trip time is measured in sequence: $\times 1(0^\circ) \rightarrow \times 1(180^\circ) \rightarrow \times 5(0^\circ) \rightarrow \times 5(180^\circ)$. After each test, reset the tripped PRCD to proceed to the next test. PASS result is given where the PRCD tripped within the rated time through all the tests.

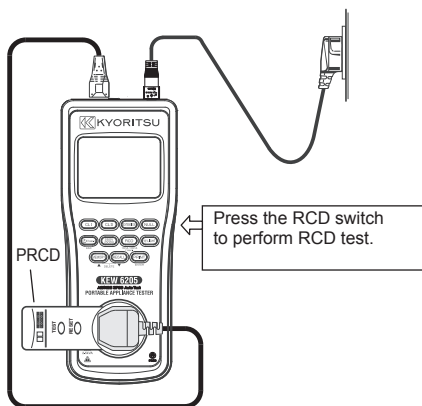

⚠ CAUTION

- The Tester can test RCDs rated at 230V+10%, -15%. Input the rated voltage of the RCD to be tested.

RCD Test Flow

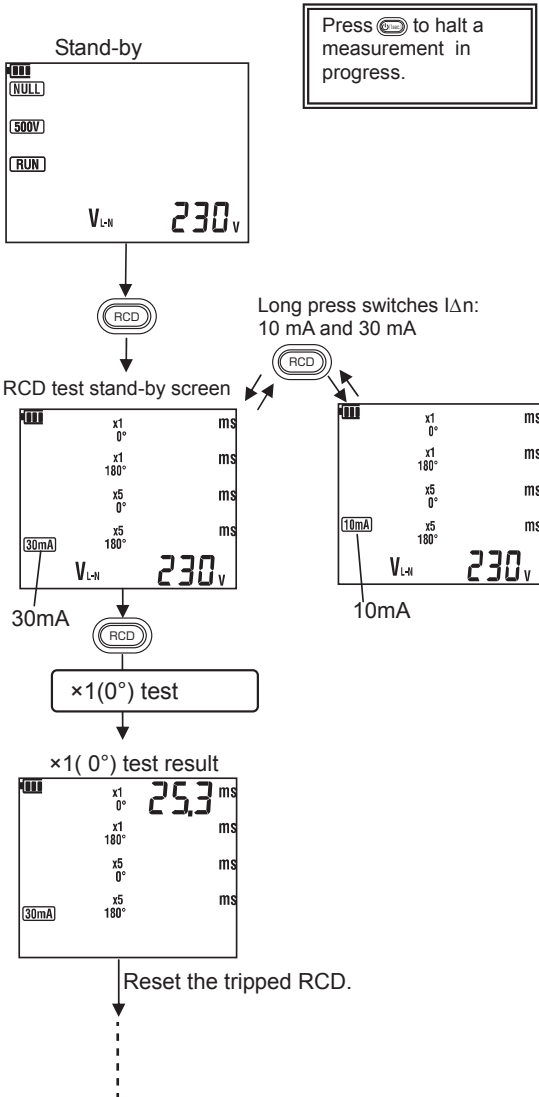

↓
×1(180°) test

↓
×1(180°) test result

x1	0°	25.3	ms
x1	180°	35.1	ms
x5	0°		ms
x5	180°		ms

30mA

↓ Reset the tripped RCD.

×5(0°) test

↓
×5(0°) test result

x1	0°	25.3	ms
x1	180°	35.1	ms
x5	0°	22.4	ms
x5	180°		ms

30mA

↓ Reset the tripped RCD.

×5(180°) test

Test results are all "PASS":

x1	0°	25.3	ms
x1	180°	35.1	ms
x5	0°	22.4	ms
x5	180°	22.5	ms

30mA

PASS

"PASS" is displayed.
(Green backlight blinks.)

If any one of test results is "FAIL":

x1	0°	310.8	ms
x1	180°	317.8	ms
x5	0°	> 400	ms
x5	180°	> 400	ms

30mA

FAIL

"FAIL" is displayed.
(Red backlight blinks.)

- Check the connection if  symbol is displayed in the LCD. Connection may be incorrect and a test doesn't start even RCD switch is pressed.
- If " $I\Delta n$ " setting is greater than the rated residual current of the RCD, the RCD will trip and "no" may be displayed on LCD.
- Special conditions of RCDs of a particular design, for example S-type, should be taken into consideration.
- ATT (Anti-Trip Technology)
The KEW6205 uses mains voltage across L-N for PRCD testing. It enables PRCD testing without tripping the RCD of mains power. It works with the connection for "(1) PRCD test" as shown above; doesn't work with the connection for "(2) PRCD test via socket outlet".

(2) PRCD test via socket outlet

Make connection as the following illustration indicates when testing a PRCD connected to a socket outlet. For this test, use MODEL7276 for connection.

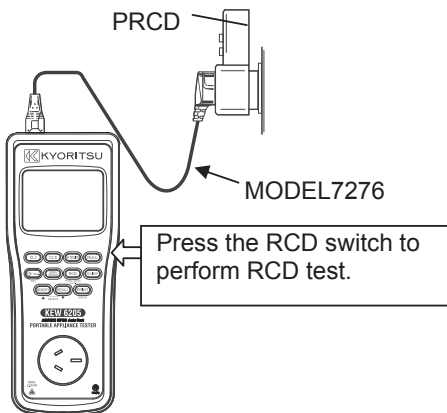

(3) Testing RCD in distribution board

Make connection as the following illustration indicates when testing an RCD installed in a distribution panel connected to a socket outlet. For this test, use MODEL7276 for connection.

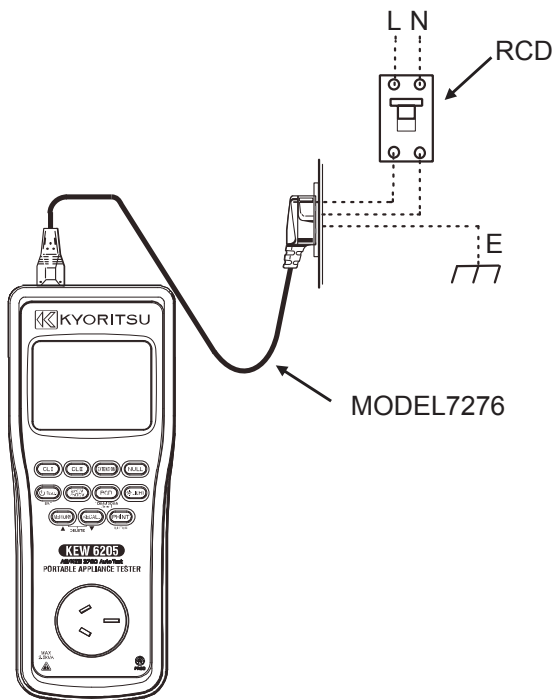

- If a fault voltage exceeds 50 V while applying a test current to test a built-in type RCD, the LCD shows “Uf. Hi” and the test is halted.
- If a voltage exists between the protective conductor and earth, it may influence the measurements.
- If a voltage exists between neutral and earth, it may influence the measurements, therefore, the connection between neutral point of the distribution system and earth should be checked before testing.
- The potential fields of other earthing installations may influence the measurement.
- Resistance of earthed electrodes in the circuit under test with a Probe - auxiliary earthed electrode - should be 200Ω or less.
- Equipment following the RCD, e.g. capacitors or rotating machinery, may cause a significant lengthening of the measured trip time.

6. Memory/ Recall function

6.1 Memory function

Test results on each function can be saved with this function. Press the Memory switch to save the displayed result. (Max: 999). Hold down the Memory switch for a while to edit the data no., site no. and device no. Data can be saved according to the following sequence.

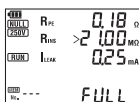
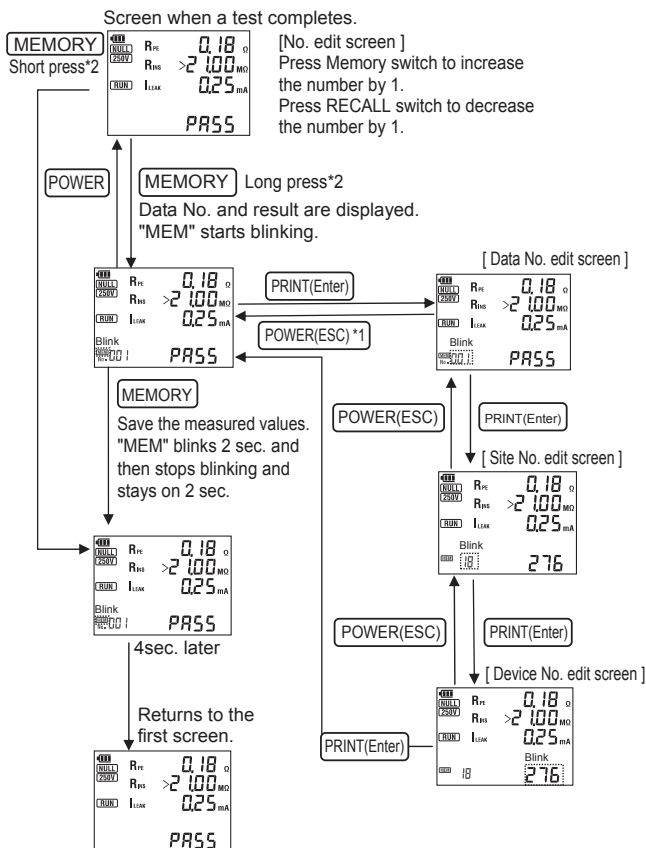

- ※1 All the changes made through edit screens will be canceled when the Power switch is pressed and the edit screen is closed.
- ※2 "FULL" appears when the number of stored results reaches to the max.
Press the POWER (ESC) switch to return to the screen showing a measured result.

6.2 Recall function

This function is to recall and display the saved data on LCD. To see the date, site no. or device no., recall the saved data on the LCD and then press the RCD switch. The data recalled with this function can also be printed out. Saved data can be recalled according to the following sequence.

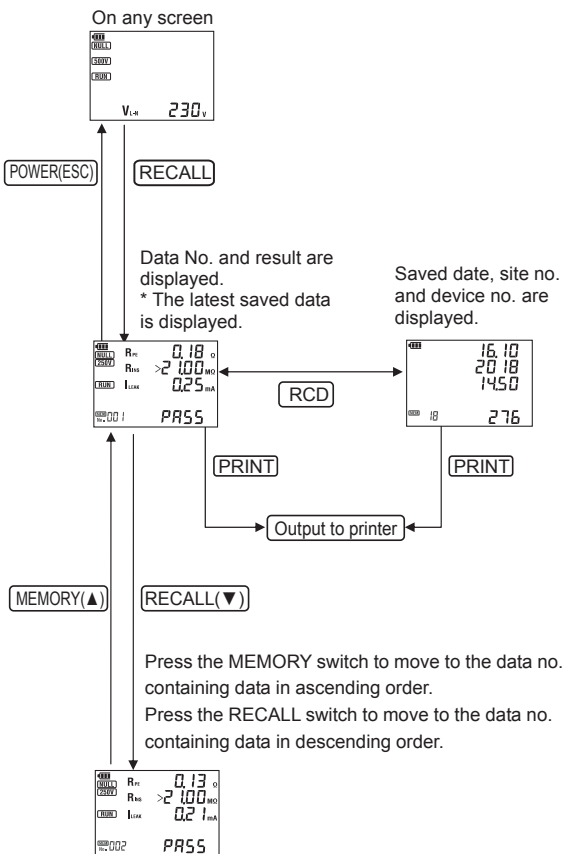

When there's no saved data:

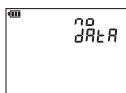

6.3 Delete the saved data

Hold down the Memory and Recall switch simultaneously while the saved data is displayed on the LCD by using Recall function. (Data won't be cleared at this moment.) Select to delete just one result or all results. Data can be deleted according to the following sequence.

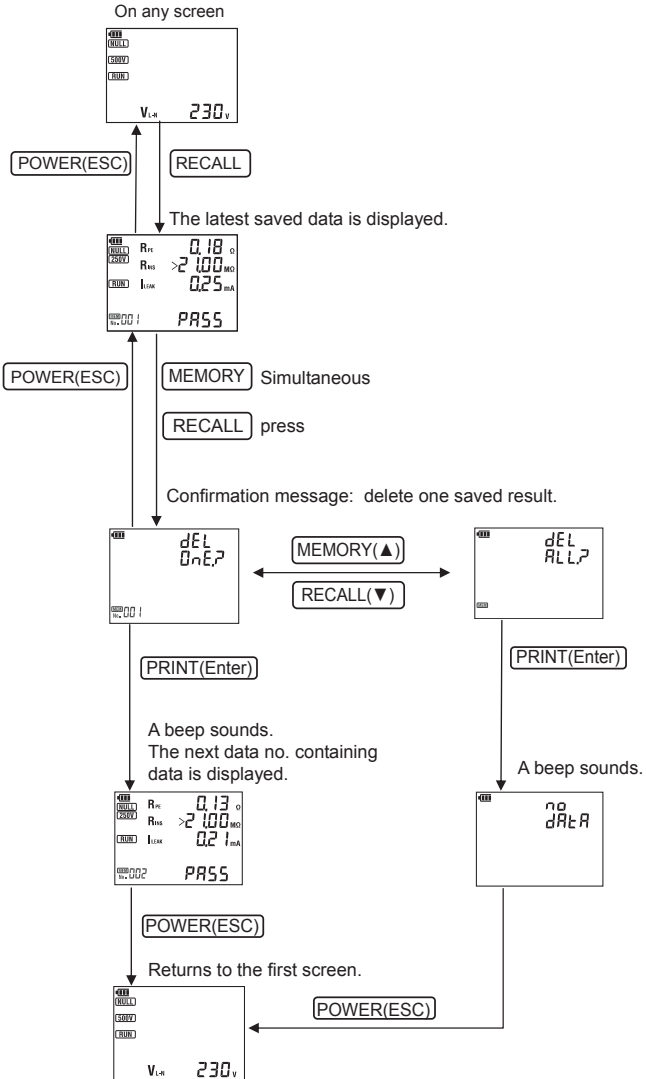

7. Print function

Test results displayed on the LCD can be transferred to a printer by pressing the PRINT switch. You can select an interval for periodic testing at printing. The selectable intervals are: 3 months (3M), 6 months (6M), 12 months (12M), 24 months (24M), 60 months (60M), and Not determined (---M). The default setting is "6M". The date for the next testing based on the selected interval is also printed on the paper. If you select "---M", the date for the next date will be blank. The selected interval is saved in the internal memory and won't be cleared even after the KEW6205 Tester is powered off. Use the optional printer cable MODEL7275 to connect a printer and the instrument. Long press of the PRINT switch can toggle and change the site no. or device no. for print.

- Compatible printer: PC42t Plus (Honeywell)

The table below shows the communication specs. (RS-232C)

Baud rate	9600bps
Parity	Non
Stop bit	1-bit
Data length	8-bit
Handshake	Xon/Xoff

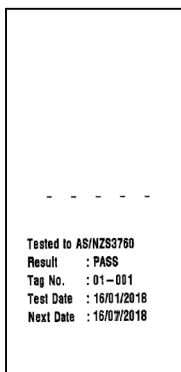
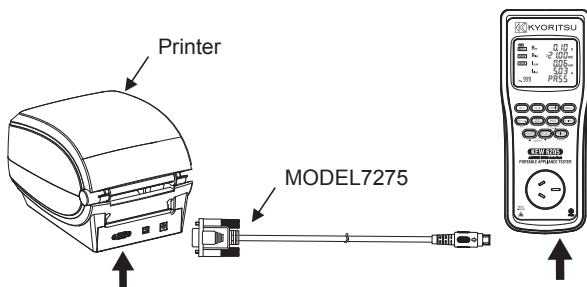

Print example

The printer setup will be enabled by inserting and uploading from a USB storage device. If you do not have the supplied USB storage device (containing printer configuration files), you can manually setup the printer by following the steps below.

To use a PC42t Plus (Honeywell) with KEW6205, settings of PC42t Plus need to be changed. Please connect your PC and PC42t Plus with a USB cable and follow the instructions below.

* For further detail, please refer to the manual supplied with the printer.

1. Printer Settings > Communications > Serial > COM1 > Baud Rate > 9600.
2. Printer Settings > Communications > Serial > COM1 > Flow Control > Hardware > Enable.
3. Printer Settings > System Settings > General > Command Language > "ZSim".

Data can be printed out according to the following sequence.

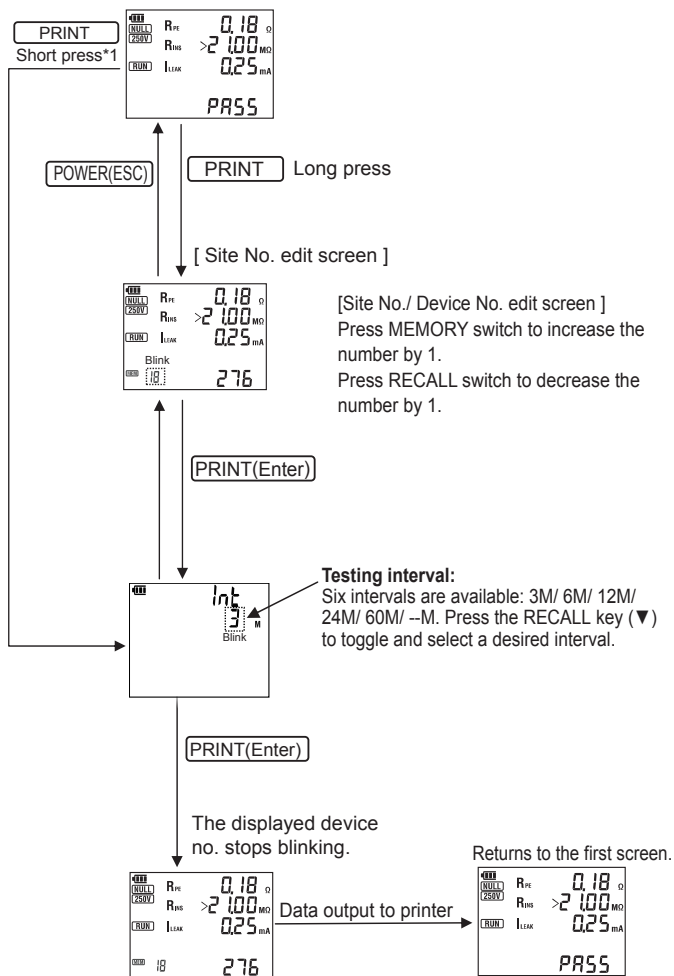

*1 On a recalled result screen, long-press action doesn't work.

8. USB communication

This instrument has USB communication to transfer the internal data to a PC. Data can be edited by using the special application KEW Report. Use the optional USB cable MODEL8263 to connect the instrument and a PC. The table below shows the USB communication specs.

Help and information on how to install KEW Report, please see the instruction manual supplied with MODEL8263-USB (optional item) or HELP in the KEW Report.

Communication method	USB Ver1.1
USB ID No.	Vender ID:12EC(Hex) Product ID:6205(Hex) Serial no.: 0 + 7-digit number
Communication speed	12 Mbps

9. Clock mode

A long press of backlight switch on any screen shows the current time. To adjust the time, press the PRINT switch while the time is being displayed.

The time can be adjusted according to the following sequence.

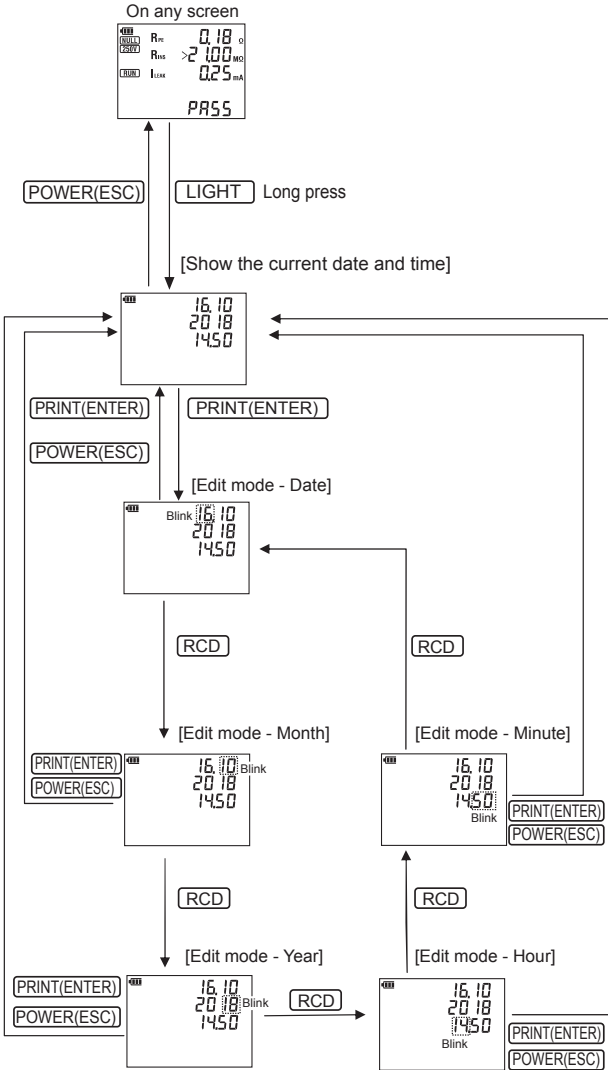

10. Backlight

Press the backlight switch to turn on the backlight. Press the switch again to turn off the backlight. The backlight automatically turns off if there is no activity for about 2 min.

11. Battery / Fuse replacement

⚠ DANGER

Never open the Battery cover during a measurement. Dispose the used batteries according to the rules, which is defined by each community.

⚠ WARNING

To avoid possible electric shock, remove test leads before opening the battery cover. After replacing batteries, be sure to tighten up the screws for battery cover.

⚠ CAUTION

Do not mix new and old batteries. Install batteries in correct polarity as marked inside the battery compartment.

11.1 Battery Replacement

- (1) Disconnect the test probe from the Tester.
- (2) Open the battery cover by unscrewing the captive screw to reveal battery compartment.
- (3) Always replace all six batteries with new ones at the same time.
“Six size AA alkaline batteries (LR6)”
- (4) Screw the battery cover back on before using the Tester.

11.2 Fuse Replacement

- (1) Disconnect the test probe from the Tester.
- (2) Unscrew the captive and open the battery compartment cover to replace the fuse.

Fuse type: 10A/250V(F)

Fast acting type ceramic fuse Φ 5 x 20mm.

- (3) Screw the battery cover back on before using the Tester.

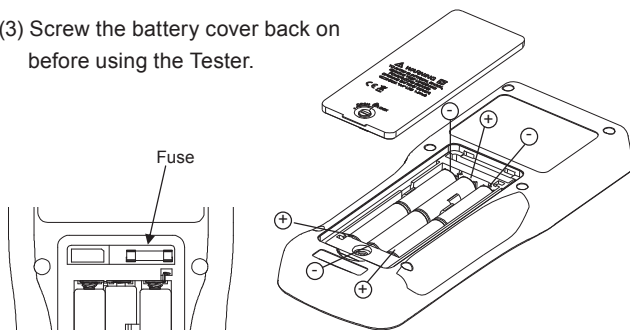

12. Shoulder strap attachment

- (1) Turn the knob counterclockwise until it stops. Then the knob comes out.

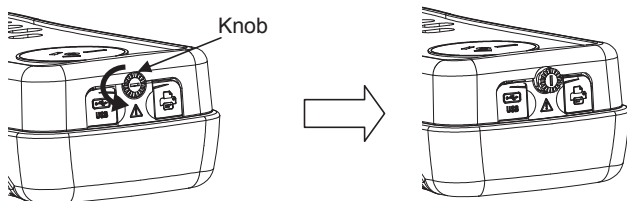

- (2) Attach the buckle of the shoulder strap and slide until it clicks.

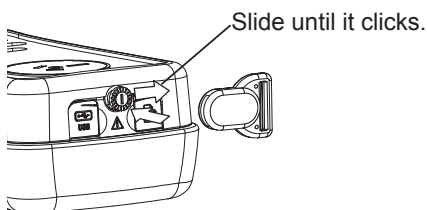

- (3) Pass the strap belt down through the buckle from the top, and up. Adjust the strap for length and secure.

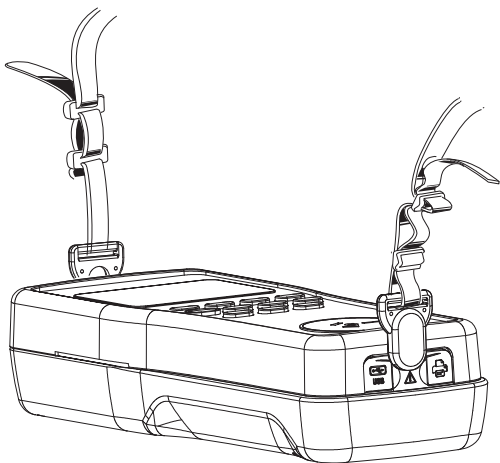

13. Maintenance

Use a very slightly damp cloth for cleaning the Tester. Do not use abrasives or solvents.

DISTRIBUTOR

Kyoritsu reserves the rights to change specifications or designs described in this manual without notice and without obligations.



KYORITSU ELECTRICAL INSTRUMENTS WORKS, LTD.

2-5-20, Nakane, Meguro-ku,
Tokyo, 152-0031 Japan
Phone: +81-3-3723-0131
Fax: +81-3-3723-0152
Factory: Ehime, Japan

www.kew-ltd.co.jp